

# 3-5NM Solar Marine Lantern

SL-75

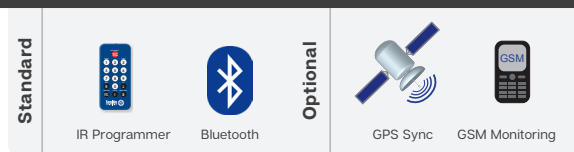

The SL-75 is a next-generation solar marine lantern with up to 5NM visible range, made from tough, durable polycarbonate and utilising the latest in technology.

## Bluetooth® for programming and maintenance

Completely programmable via the new Bluetooth® connected SealitePro™ mobile application, the SL-75 can be configured and monitored from a distance up to 50 meters. An inbuilt calculator confirms the lanterns ability to operate at the set location, ensuring optimal operating performance.

## Dual High Performance Solar Modules

The SL-75 lantern boasts dual high-performance solar modules which are tilted to obtain maximum sunlight capture, allowing the unit to operate reliably in a range of low sunlight environments. The tilted solar modules are also less susceptible to fouling or snow cover.

## Improve productivity and reduce risk to personnel

Time savings for maintenance work are maximised as diagnostics can be interrogated via the mobile device. Risk to maintenance personnel is greatly reduced as many maintenance tasks can be performed from the safety of a vessel or without the need to climb structures.

## Optional GPS Synchronisation

The SL-75 is available with optional GPS Synchronisation. Two (2) or more lights can be synchronised to flash in unison via an internal GPS module.

## Optional GSM Monitoring & Control System

The SL-75 may also be fitted with GSM Cell-Phone Monitoring and Control – enabling users to access real-time diagnostic data and change lantern settings via cell-phone. The system can also be configured to send out alarm SMS text messages to designated phone numbers. Users can also have alarms and reports sent to designated email addresses.

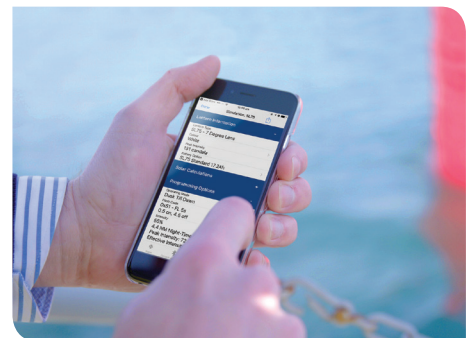
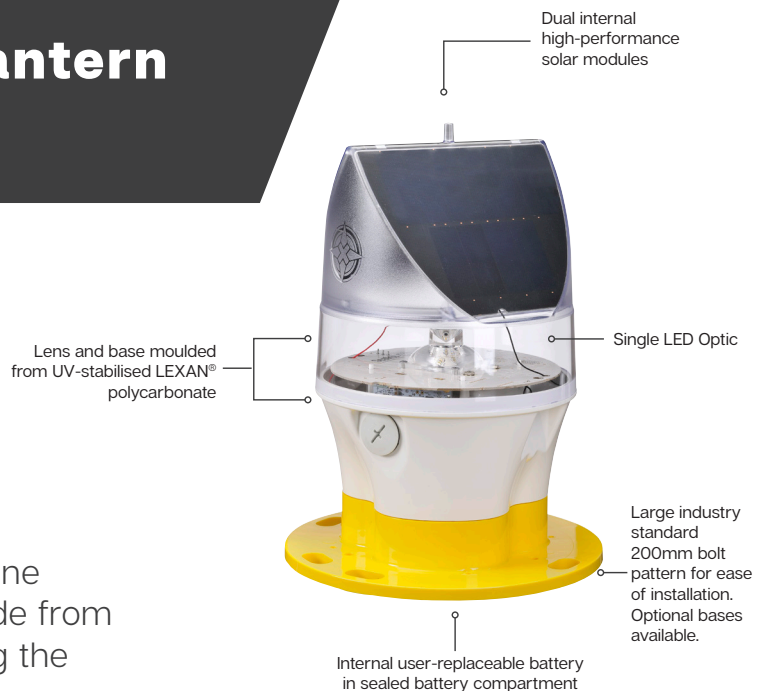

SealitePro™ app

## Advantage

- Up to 310 Flash characters including 256 IALA Flash characters and customer definable character
- Up to 5NM visible range

## Reliable

- High Capacity NiMH battery for long service life & wide temperature range
- Reliable year-round operation in low sunlight conditions
- Bluetooth® for programming and maintenance via SealitePro™ app

## Optional Add Ons

- GPS Synchronisation
- GSM Cell-Phone Monitoring

## Technical Specifications \*\*

SL-75	
<b>Light Characteristics</b>	
Light Source	High efficiency LED
Available Colours	Red, Green, White, Yellow, Blue
SL-75-7D Typical Maximum Intensity (cd)	Red - 98 Green - 104 White - 131 Yellow - 65
SL-75-5D Typical Maximum Intensity (cd)	Red - 143 Green - 109 White - 183 Yellow - 87
Visible Range (NM/km)	3-5 / 5.5 - 9
Horizontal Output (degrees)	360
Vertical Divergence (degrees)	7.5 (standard) / 5 (optional)
Available Flash Characteristics	310 plus custom character
Intensity Adjustments	Multiple intensity settings
LED Life Expectancy (hours)	>100,000
<b>Electrical Characteristics</b>	
Circuit Protection	Integrated
Nominal Voltage (VDC)	3.6
Autonomy (days)	>30 (14 hour darkness, 12.5% duty cycle)
Temperature Range	-40 to 80°C
<b>Solar Characteristics</b>	
Solar Module Type	Monocrystalline
Output (watts)	5 (2 x 2.5watt)
<b>Power Supply</b>	
Battery Type	High grade NiMH
Battery Capacity (Ah) - Standard	17.2
Battery Capacity (Ah) - Large	21.5
Nominal Voltage (V)	3.6
<b>Physical Characteristics</b>	
Body Material	LEXAN® Polycarbonate – UV stabilized
Lens Material	LEXAN® Polycarbonate – UV stabilized
Lens Design	Single LED Optic
Mounting	3 types: 3 & 4 hole 200mm bolt pattern, 3 hole 150mm bolt pattern, 4 hole 162mm bolt pattern
Height (mm/inches)	314 / 12 <sup>3/8</sup>
Width (mm/inches)	231 / 9 <sup>1/8</sup>
Mass (lbs/kg)	5.5 / 2.5
Product Life Expectancy	Up to 12 years
<b>Certifications</b>	
EMC	FCC Part 15 Rules & ANSI C63.4: 2014. EN61000-6-2: 2005 (IEC 61000-6-2:2005) Part 6-2 Immunity. EN 61000-6-4: 2007 (IEC 61000-6-4: 2006) Electromagnetic compatibility (EMC) - Part 6-4 Emission. IEC 61000-4-2: 2008 Ed 2 Part 4-2 Electrostatic discharge immunity test. IEC 61000-4-3: 2006 Ed 3 Part 4-3. Radiated, radio-frequency, electromagnetic field immunity. Signal colours compliant to IALA E-200-1
IALA	ISO9001:2015
Quality Assurance	
Waterproof	IP68
<b>Intellectual Property</b>	
Trademarks	SEALITE® is a registered trademark of Sealite Pty Ltd
Warranty *	3 years
Options Available	<ul style="list-style-type: none"> <li>GPS Synchronisation</li> <li>Bird Deterrent</li> <li>SL-75-5D (5 Degree divergence model)</li> <li>GSM Monitoring &amp; Control System</li> <li>Charging Port</li> </ul>

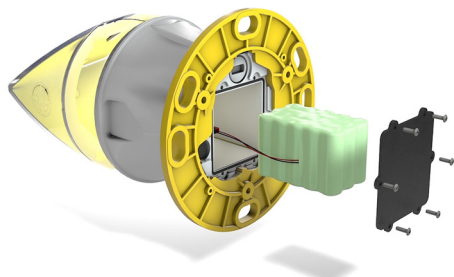

	Typical Maximum Intensity (cd)	
	SL-75-7D	SL-75-5D
<b>RED</b>	98	143
<b>GREEN</b>	104	109
<b>WHITE</b>	131	183
<b>YELLOW</b>	65	87

## Technical Illustrations

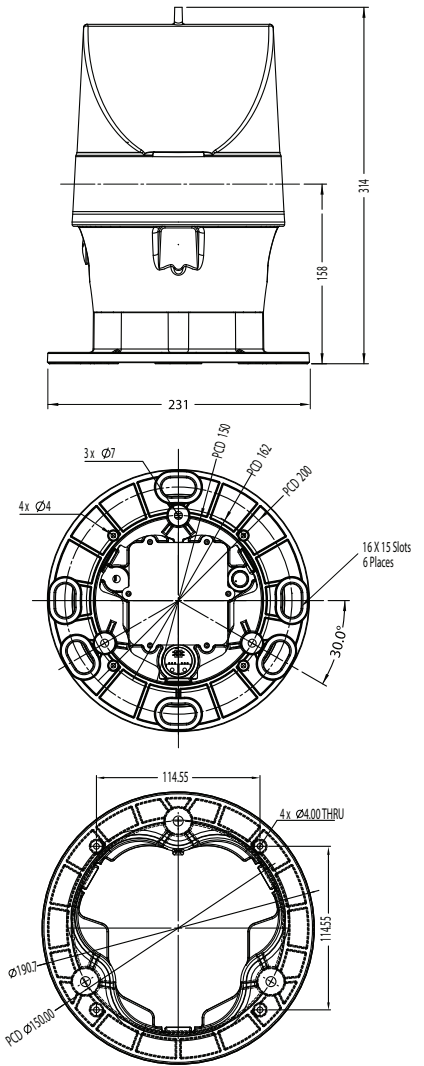

## Photometric Output

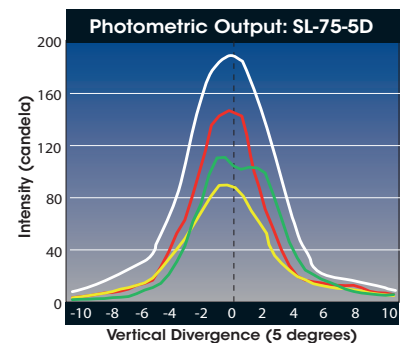
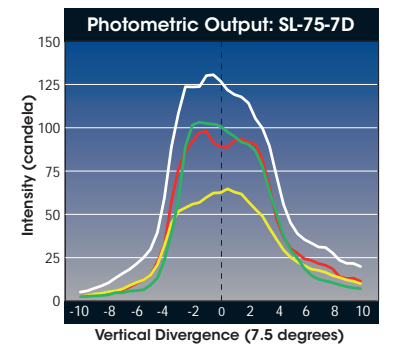

We believe technology improves navigation™